

**ERSATZTEILE**  
**SPARE PARTS**

**OZ**

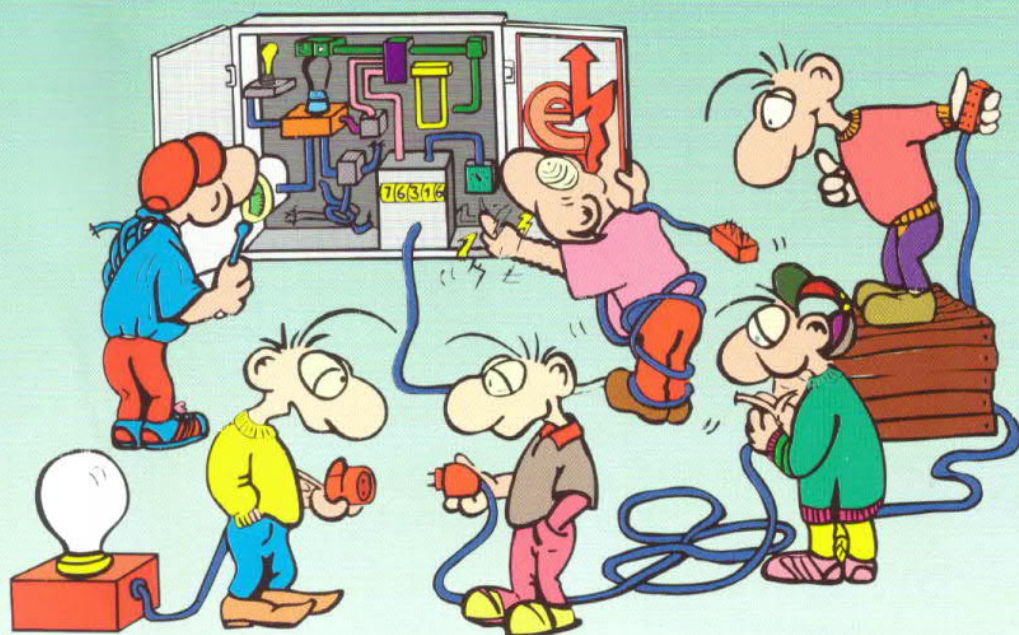

**SONDERAUSSTATTUNGEN**  
**SPECIAL EQUIPMENTS**

**DEYLE**



# B

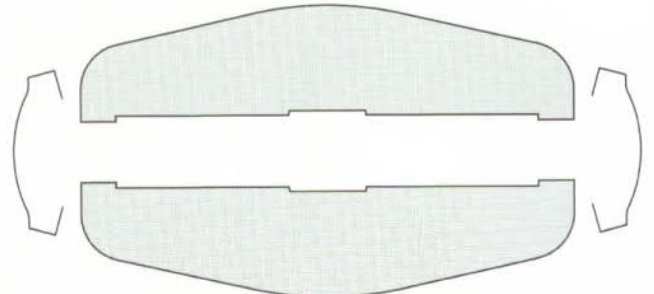

OZAK-B/R ( 1:2 )

1:1

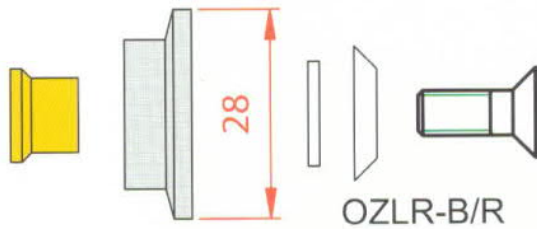

OZLR-B/R

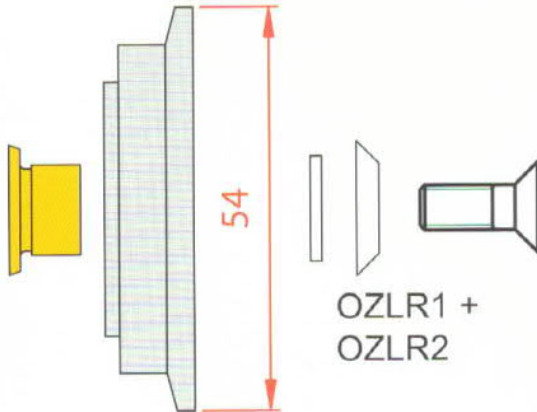

OZLR1 +  
OZLR2

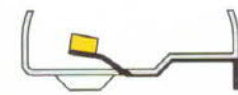

OZLB-B ( PE ) ( 1:2 )

OZSK3-B

OZSK2-B

OZSK1-B

( 1:2 )

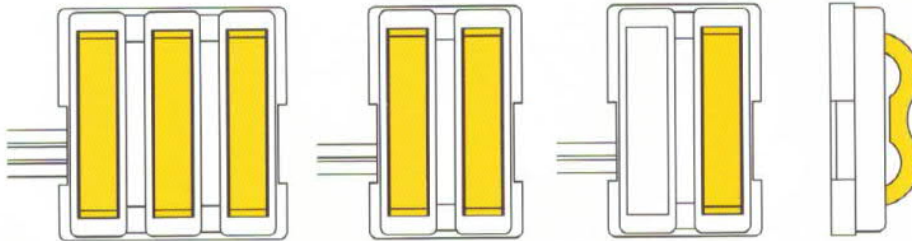

OZLA137 ( 50A )  
OZLA138 ( 100A )

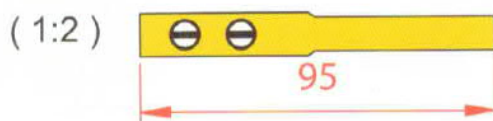

OZLA050B/R ( 50A )  
OZLA100B/R ( 100A )

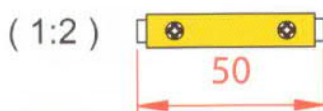

OZLV050B/R ( 50A )  
OZLV100B/R ( 100A )

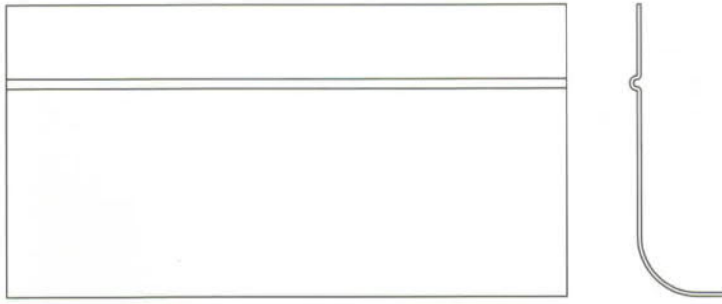

OZVB1-B (BAN3...,  
BAN5... )  
OZVB1-B7 (BAN7... )  
OZVB1-R (RAN9... ,  
RAN11... )

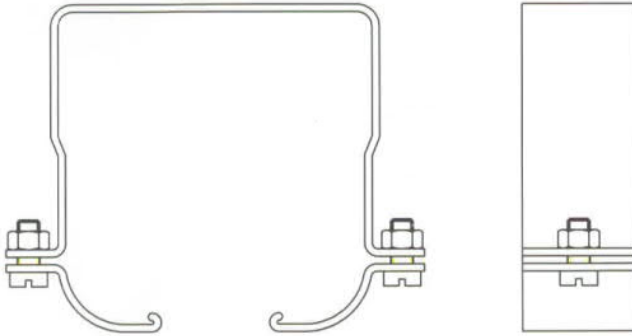

OZSB-B (BAN3...,  
BAN5... )  
OZSB-B7 (BAN7... )  
OZSB-R (RAN9... ,  
RAN11... )



ZKSFO 0114 (BAN3..., BAN5..., BAN7...)

ZKSFO 0115 (RAN9..., RAN11...)

( 1:2 )

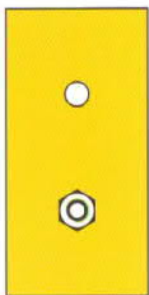

OZVL ( 1:2 )

BAN3..., BAN5...,  
BAN7...,  
RAN9..., RAN11...

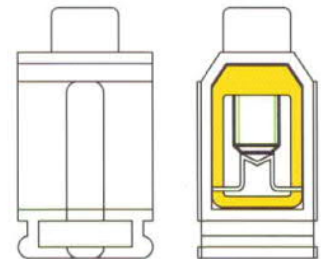
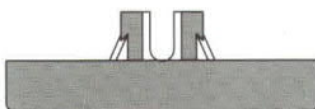
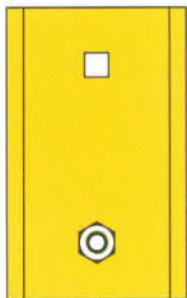

OZAK-B

1:1

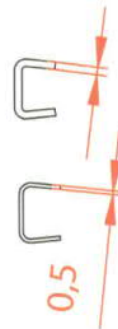

OZCU100B  
( 4000 mm)

OZCU050B  
( 4000 mm)

# D

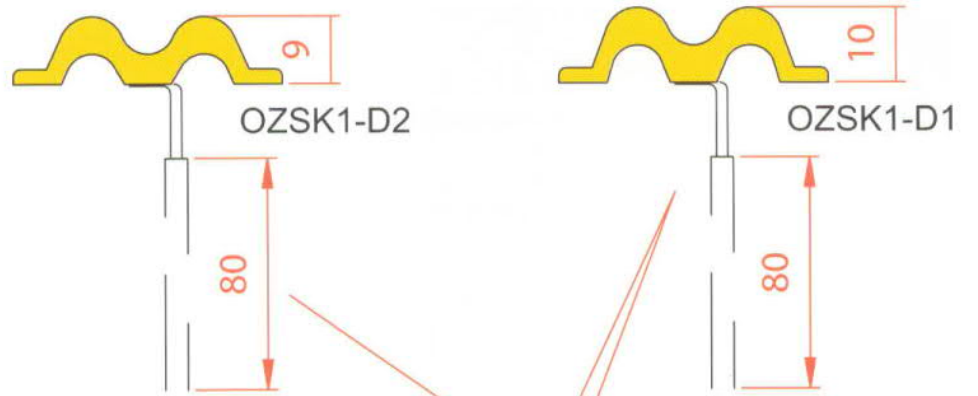

OZCU050D  
(4030mm)



OZCU025D  
(4030mm)

1:1

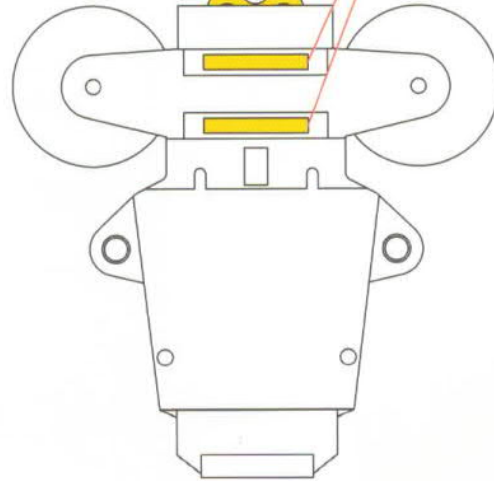

ZKSFO 1415

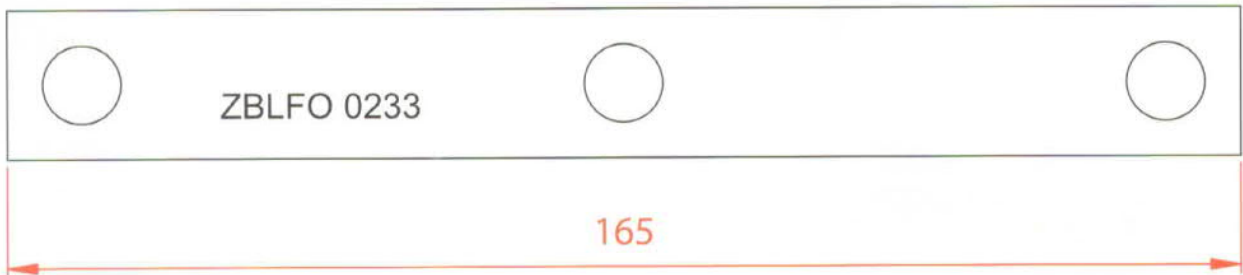
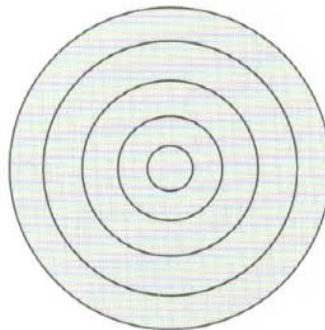

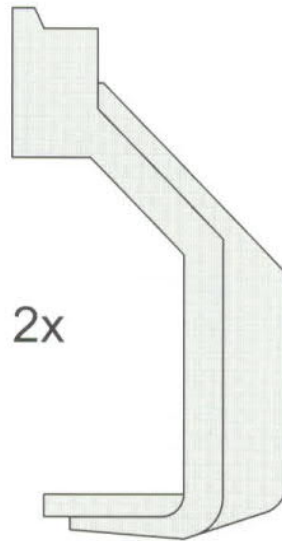
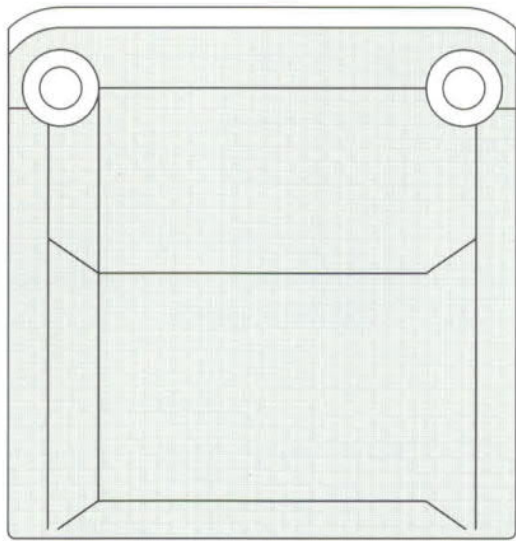

OZVB2-D

2x

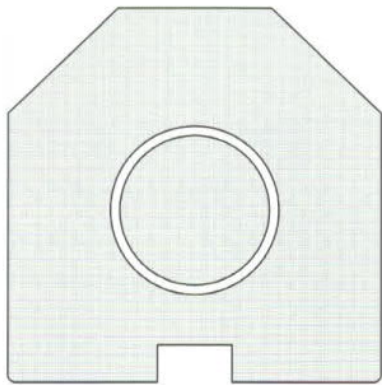

ZKSFO 0116

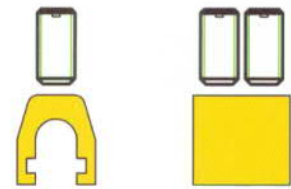

OZAK-D

1:1

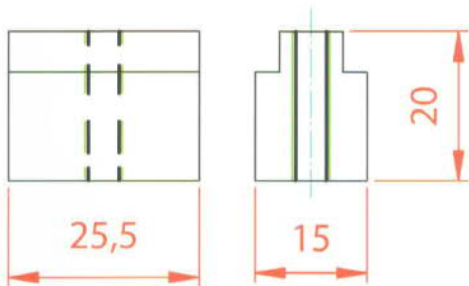

OZ10019

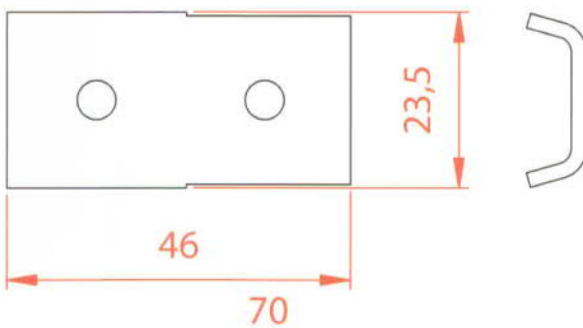

OZ5007



OZ5012

# S

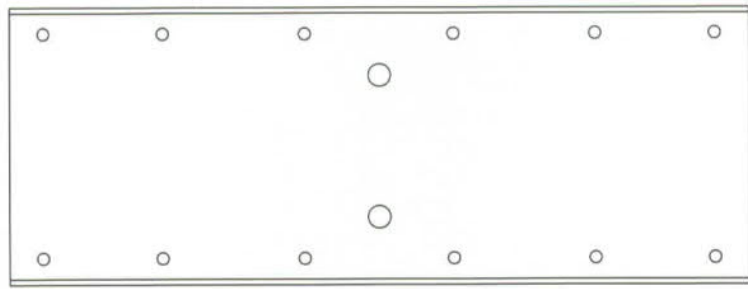

ZBLFO 5109

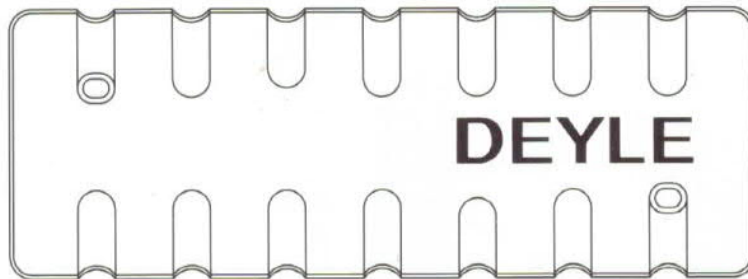

ZKSFO 5081

1:2

ZBFTE 10336

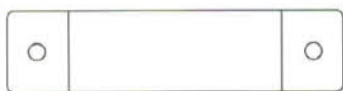
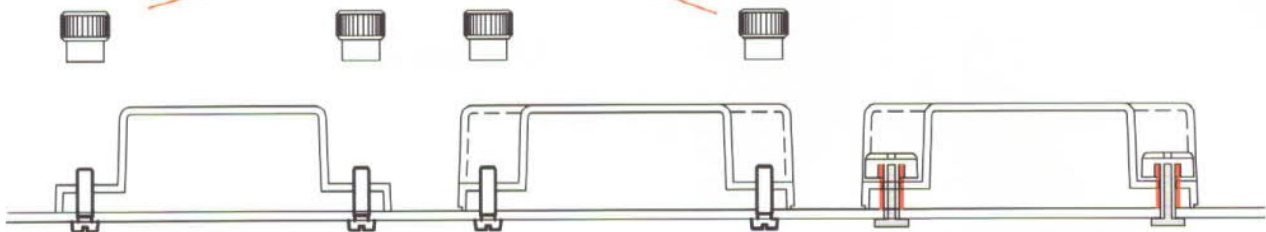

ZKSFO 5018

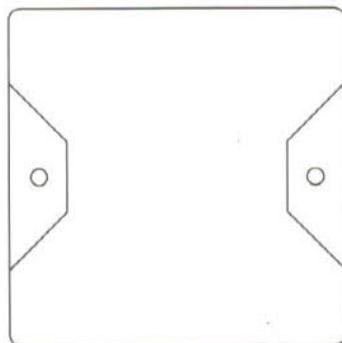

ZKSFO 5079

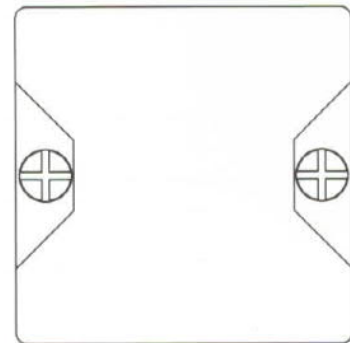

OZSDP4-S

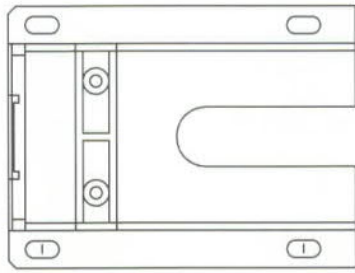

ZKSFO5156

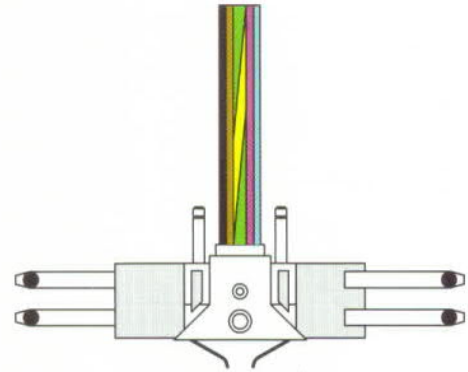

OZSO-S



OZAD0-S



OZAD1-S

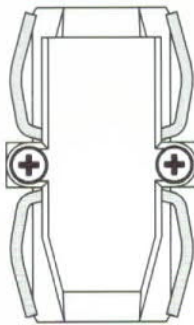

- OZVK-S25 ( 25A )
- OZVK-S40 ( 40A )
- OZVK-S63 ( 63A )

1:2

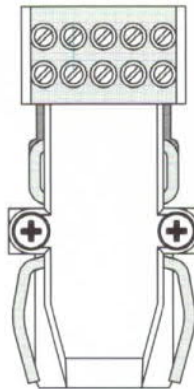

OZAK-SAS5-40



- OZAK-SAS5-40L/R
- OZAK-SAS5-40R/L



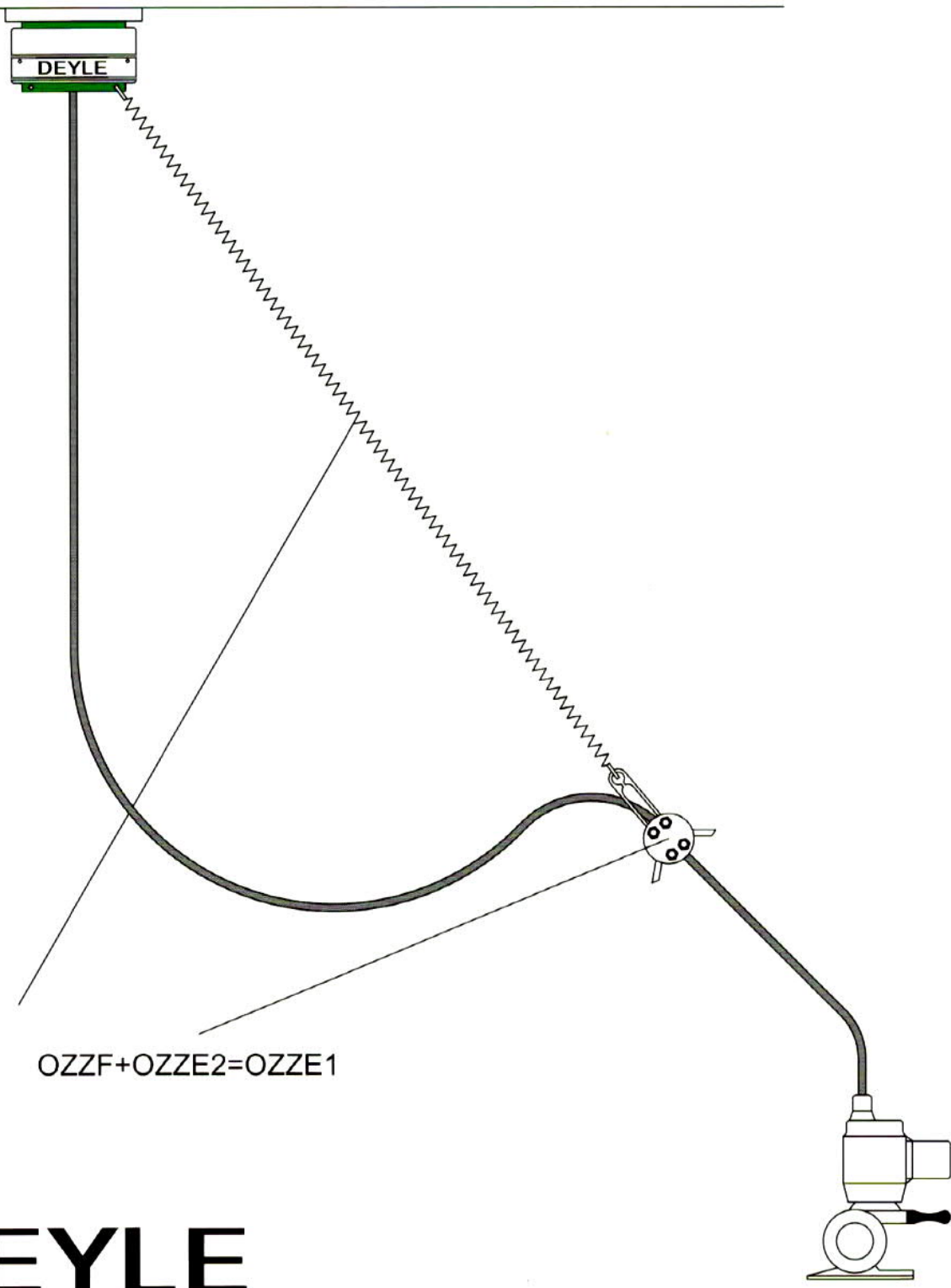

# DEYLE

ein Unternehmen der Mehl-Gruppe

DEYLE GmbH  
Tulpenstraße 50  
71394 Kernen i. R. (Rommelshausen)  
Telefon (0 71 51) 4 10 46-47  
Telefax (0 71 51) 4 68 06  
mail@deyle-power.de  
www.deyle-power.de

Technische Änderungen und Irrtum vorbehalten.  
In the interest of continual improvement, we reserve the right to alter specifications without prior notice. (01.2007)